

MBRF10150CT

10 AMPERES SCHOTTKY BARRIER RECTIFIERS

FEATURES

- Plastic package has Underwriters Laboratory Flammability Classification 94V-O. Flame Retardant Epoxy Molding Compound.
- Metal silicon junction, majority carrier conduction
- Low power loss, high efficiency.
- High current capability
- Guardring for overvoltage protection
- For use in low voltage, high frequency inverters free wheeling, and polarity protection applications.
- Lead free in comply with EU RoHS 2002/95/EC directives

MECHANICAL DATA

- Case: ITO-220AB molded plastic
- Terminals: solder plated, solderable per MIL-STD-750, Method 2026
- Polarity: As marked.
- Mounting Position: Any
- Weight: 0.055 ounces, 1.5615 grams.

ITO-220AB

Unit : inch(mm)

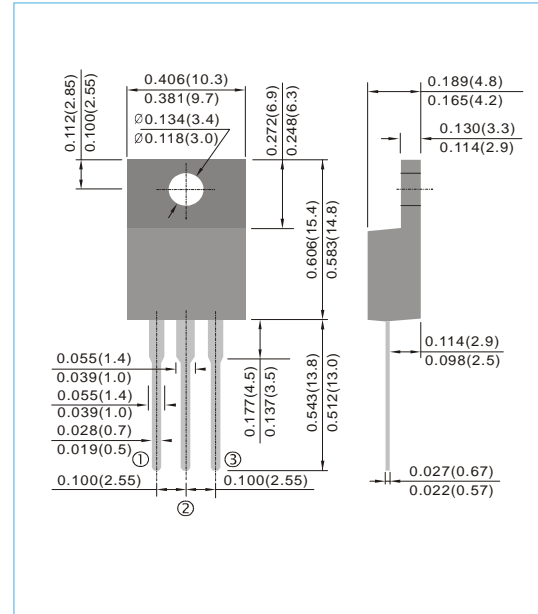

MAXIMUM RATINGS AND ELECTRICAL CHARACTERISTICS

Ratings at 25°C ambient temperature unless otherwise specified. Single phase, half wave, 60 Hz, resistive or inductive load.

For capacitive load, derate current by 20%

PARAMETER	SYMBOL	MBRF10150CT	UNITS
Maximum Recurrent Peak Reverse Voltage	V_{RRM}	150	V
Maximum RMS Voltage	V_{RMS}	105	V
Maximum DC Blocking Voltage	V_{DC}	150	V
Maximum Average Forward Current (See fig.1)	$I_{F(AV)}$	10	A
Peak Forward Surge Current : 8.3ms single half sine-wave superimposed on rated load (JEDEC method)	I_{FSM}	150	A
Maximum Forward Voltage at 5A, per leg	V_F	0.9	V
Maximum DC Reverse Current at Rated DC Blocking Voltage $T_j=25^{\circ}C$ $T_j=125^{\circ}C$	I_R	0.001 20	μA
Typical Thermal Resistance	$R_{\theta JC}$	2	$^{\circ}C / W$
Operating and Storage Junction Temperature Range	T_j, T_{STG}	-65 to + 175	$^{\circ}C$

MBRF10150CT

RATING AND CHARACTERISTIC CURVES

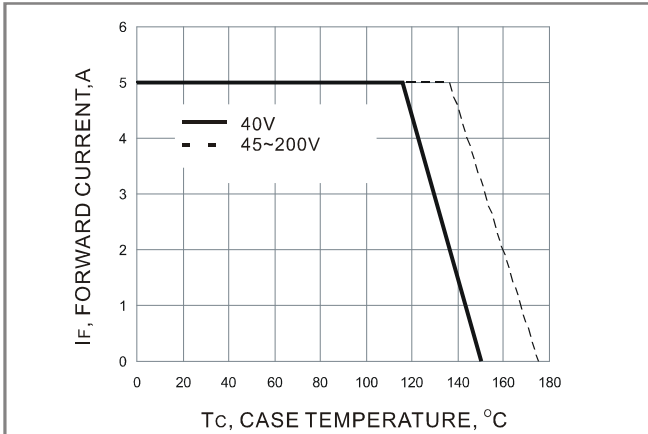

Fig.1- FORWARD CURRENT DERATING CURVE

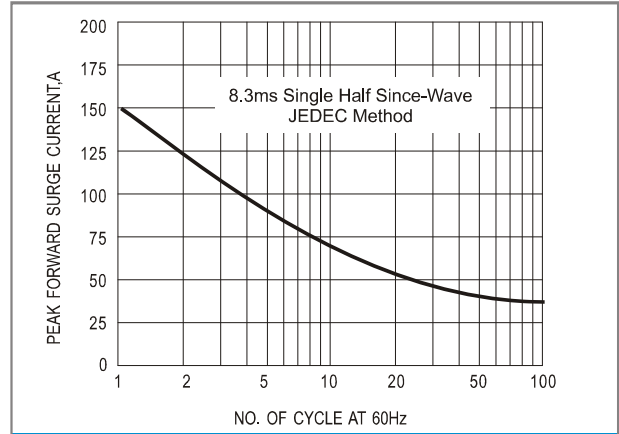

Fig.2- TYPICAL INSTANTANEOUS FORWARD CHARACTERISTICS

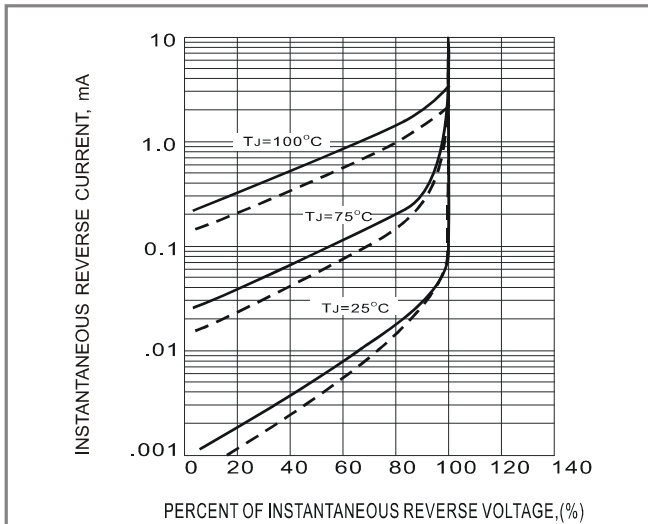

Fig.3- TYPICAL REVERSE CHARACTERISTICS

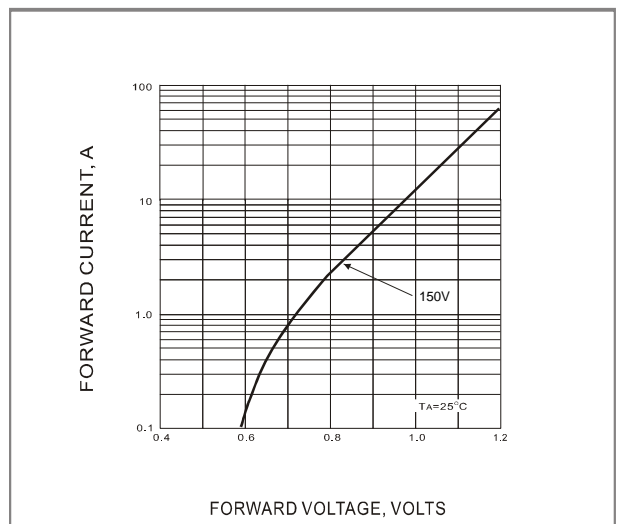

Fig.4- TYPICAL INSTANTANEOUS FORWARD CHARACTERISTIC