

MURF10400CT

SUPERFAST RECOVERY RECTIFIERS

VOLTAGE 400Volts **CURRENT** 10 Amperes

ITO-220 AB Unit : inch(mm)

FEATURES

- Plastic package has Underwriters Laboratory Flammability Classification 94V-O. Flame Retardant Epoxy Molding Compound.
- Exceeds environmental standards of MIL-S-19500/228
- Low power loss, high efficiency.
- Low forward voltage, high current capability
- High surge capacity.
- Super fast recovery times, high voltage.

MECHANICAL DATA

- Case: ITO-220AB Molded plastic
- Terminals: Lead solderable per MIL-STD-750, Method 2026
- Polarity: As marked.
- Standard packaging: Any
- Weight: 0.0655 ounces, 1.859grams.

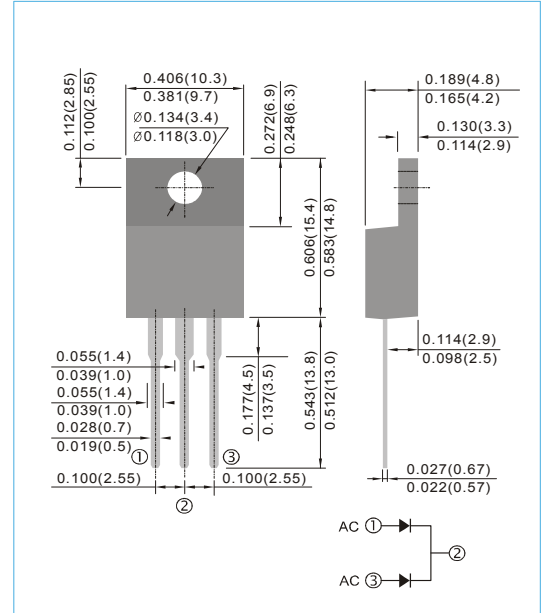

MAXIMUM RATING AND ELECTRICAL CHARACTERISTICS

Ratings at 25°C ambient temperature unless otherwise specified. Single phase, half wave, 60 Hz, resistive or inductive load. For capacitive load, derate current by 20%

PARAMETER	SYMBOL	MURF10400CT	UNITS
Maximum Recurrent Peak Reverse Voltage	V_{RRM}	400	V
Maximum RMS Voltage	V_{RMS}	280	V
Maximum DC Blocking Voltage	V_{DC}	400	V
Maximum Average Forward Current at $T_c = 100^\circ\text{C}$	$I_{F(AV)}$	10	A
Peak Forward Surge Current, 8.3ms single half sine-wave superimposed on rated load (JEDEC method)	I_{FSM}	150	A
Maximum Forward Voltage at 5A, per element	V_F	1.3	V
Maximum DC Reverse Current at Rated DC Blocking Voltage $T_j = 25^\circ\text{C}$ $T_j = 100^\circ\text{C}$	I_R	1 500	μA
Maximum Reverse Recovery Time (Note 2)	t_{rr}	50	ns
Typical Junction Capacitance (Note 1)	C_j	62	pF
Typical Thermal Resistance	$R_{\theta JC}$	3	$^\circ\text{C} / \text{W}$
Operating Junction and Storage Temperature Range	T_j, T_{STG}	-55 to +150	$^\circ\text{C}$

NOTES:

1. Measured at 1 MHz and applied reverse voltage of 4.0 VDC.
2. Reverse Recovery Test Conditions: $I_F = .5\text{A}$, $I_R = 1\text{A}$, $I_{rr} = .25\text{A}$.
3. Both Bonding and Chip structure are available.

MURF10400CT

RATING AND CHARACTERISTIC CURVES

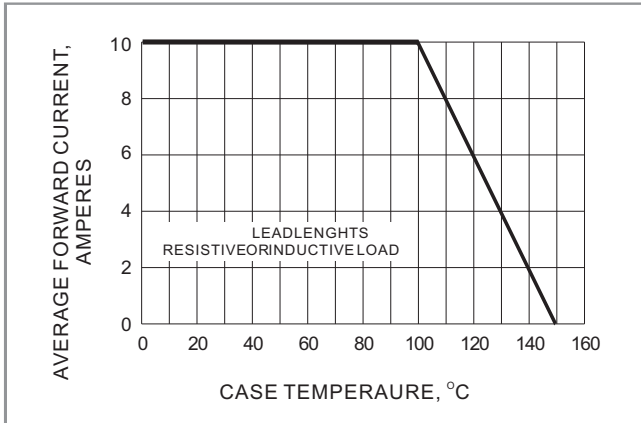

Fig.1- FORWARD CURRENT DERATING CURVE

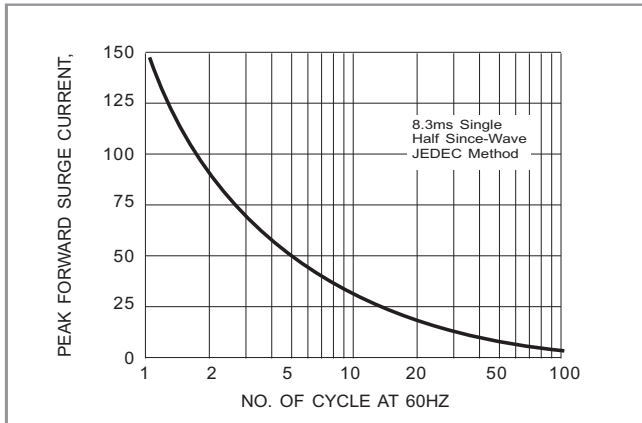

Fig.2- MAXIMUM NON-REPETITIVE SURGE CURRENT

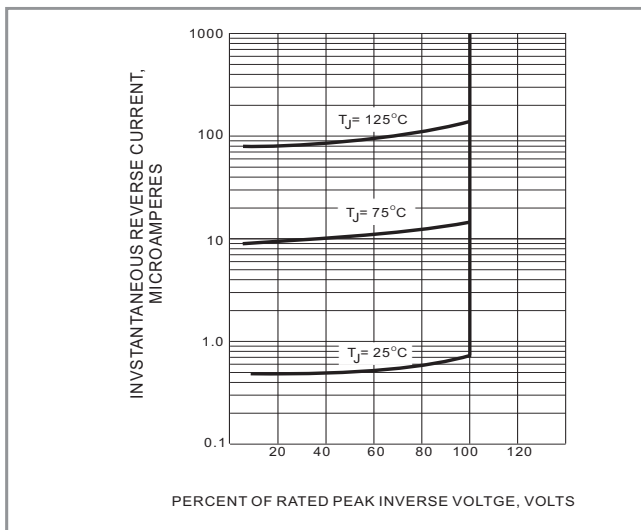

Fig.3- TYPICAL REVERSE CHARACTERISTIC

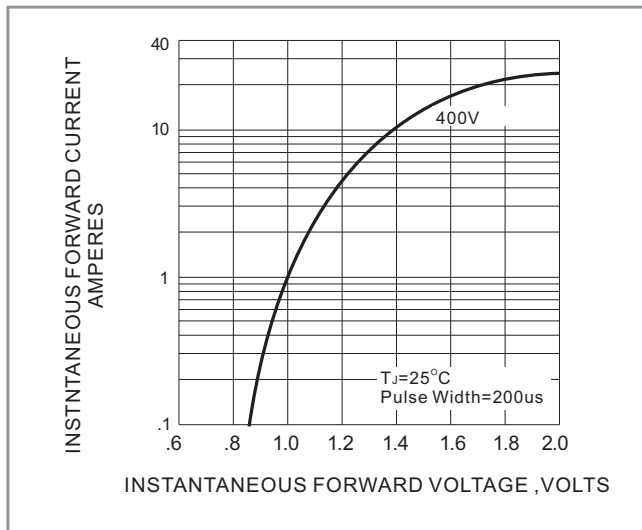

Fig.4- TYPICAL INSTANTANEOUS FORWARD CHARACTERISTIC